

版次	变更摘要	日期
0	新产品发行	2016/9/25
1	客诉公母座对配保持力偏小, 设变胶芯两侧加胶凸点	2018/10/30

序号	品名	材质
①	1.0- E型卧式WTB胶芯	LCP UL94V-0 自然色
②	1.0- E型立式WTB端子	铜合金/表面镀锡
③	1.0- E型卧式WTB焊片	铜合金/表面镀锡
④	1.0- E型立式吸盖	LCP UL94V-0 自然色

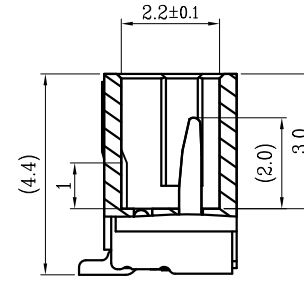

SECTION A-A

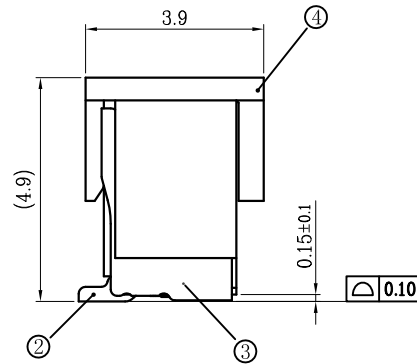
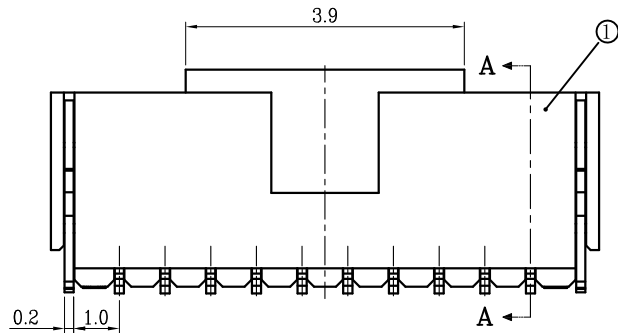
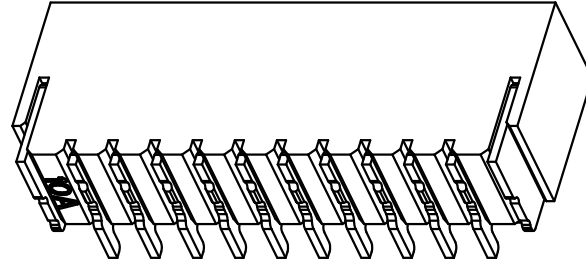
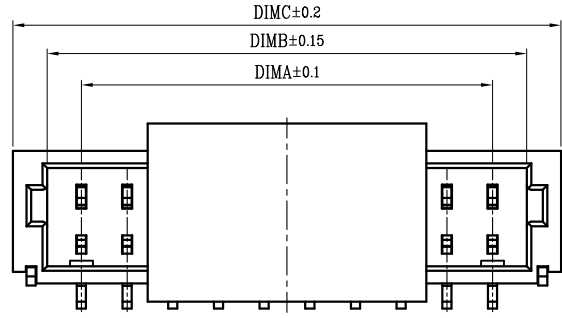
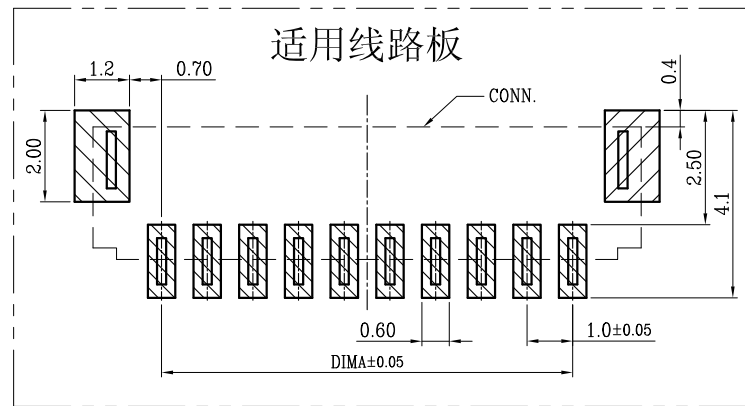
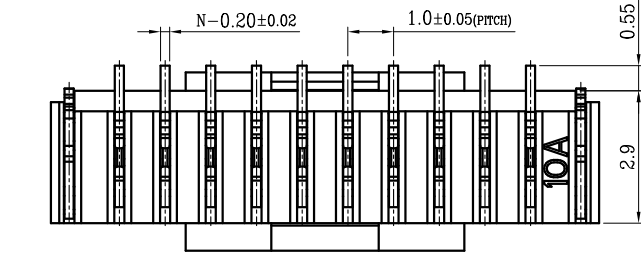

CKT	DIM A	DIM B	DIM C
2	1.00	2.50	4.00
3	2.00	3.50	5.00
4	3.00	4.50	6.00
5	4.00	5.50	7.00
6	5.00	6.50	8.00
7	6.00	7.50	9.00
8	7.00	8.50	10.00
9	8.00	9.50	11.00
10	9.00	10.50	12.00
11	10.00	11.50	13.00
12	11.00	12.50	14.00
13	12.00	13.50	15.00
14	13.00	14.50	16.00
15	14.00	15.50	17.00
16	15.00	16.50	18.00
17	16.00	17.50	19.00
18	17.00	18.50	20.00
19	18.00	19.50	21.00
20	19.00	20.50	22.00
22	21.00	22.50	24.00
24	23.00	24.50	26.00
26	25.00	26.50	28.00

技术指标:

- 塑件表面应光洁、无毛边、无明显收缩、缺陷、裂纹等现象。
- 温度范围: -25° C~85° C.
- 额定电压: 50V, AC.
- 接触电阻: ≤0.02Ω.
- 绝缘电阻: ≥100MΩ.
- 额定电流:  
适用电线型号: a. AWG#28: 1.0A(per pin)  
b. AWG#30: 1.0A(per pin)  
c. AWG#32: 0.8A(per pin)

7. 产品料号:



Plating (电镀方式)

- 0: 端子全雾锡
- 1: 端子全金 (G/F OVERALL)
- 4: 端子全亮锡

Packing (包装方式)

- T: TUBE管装
- R: TAPE & REEL卷装
- C: TAPE & REEL WITH COVER加吸盖卷装



一般公差 (TOLERANCE)  
X ±.50 XX ±.10  
X ±.20 XXX ±.05  
ANGLES ±1°

**WFD<sub>CONN</sub>** 深圳市旺富达电子有限公司  
SHEN ZHEN WFD ELECTRONICS CO., LTD

品名 (TITLE)	1.00 Pitch E型立式WTB	制图 (DR)	LIU MIAO
料号 (DWG.NO)	WFD-100EL-024C-0W	校对 (CHKD)	
比例 (SCALE)	1:1	审核 (APPD)	
单位 (UNITS)	mm	张数 (SHEET)	1 OF 1
		SIZE	A4
		REV	A