

RoHS

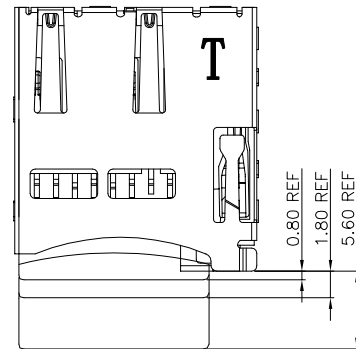

REV.	EC#	DESCRIPTION	DATE	DRAWING	CHECKED	APPROVED
A0		NEW RELEASE	10/21' 19	LIU MIAO	SIMON	DAVID

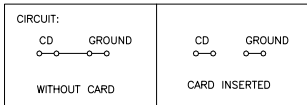
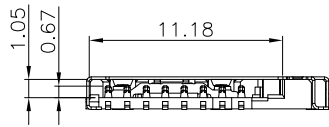
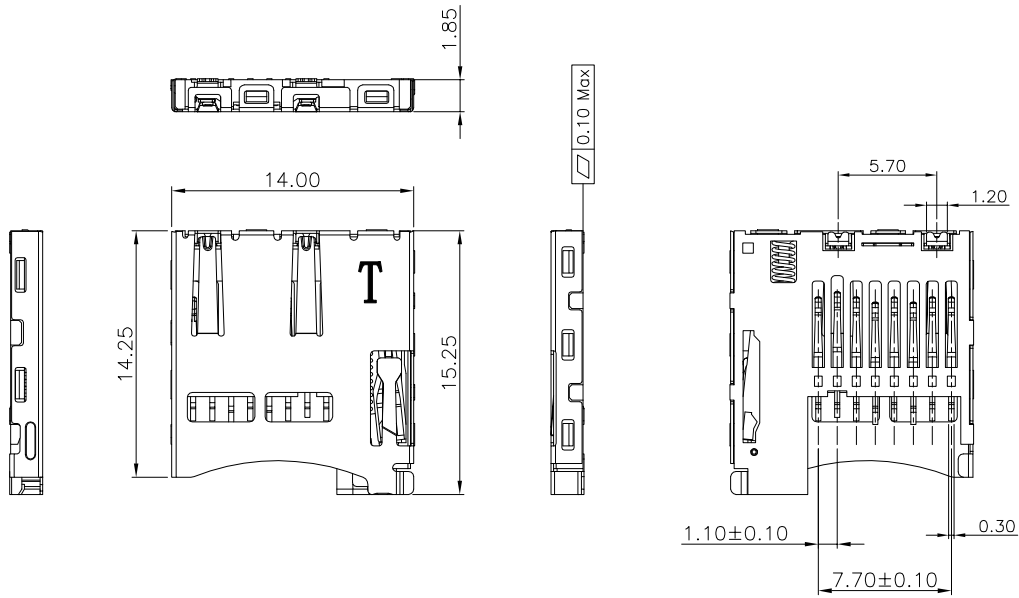
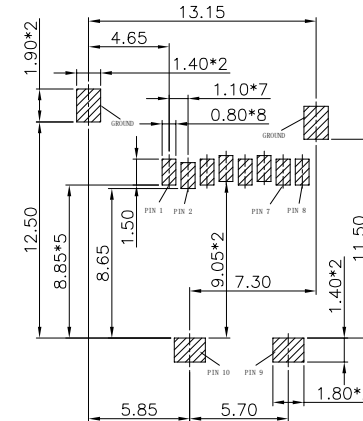

PCB HOLES (PATTERN SIDE)  $t=1.60mm$

NOTE: GENERAL TOLERANCE:  $\pm 0.1mm$

Pin No.	MICRO SD
PIN1	DAT2 1P
PIN2	CD/DAT3 2P
PIN3	CMD 3P
PIN4	VDD 4P
PIN5	CLK 5P
PIN6	VSS 6P
PIN7	DATO 7P
PIN8	DAT1 8P
PIN9	CARD DETECT
PIN10	

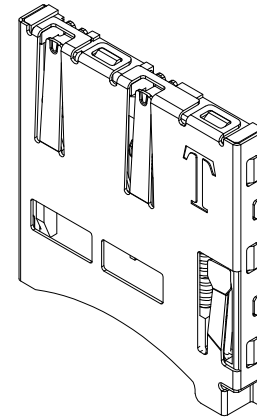

一、材料及其电镀规格:

1. 外壳: SUS304; 电镀镍底30u", 外壳脚刷金0.5";
2. 端子: C5191; 电镀镍底30u", 锡脚(上锡区域)镀锡100u", 弹高(接触区域)刷金1u";
3. 主体/滑块: LCP;
4. 接地片: C2680; 镍打底30u"Min, 镀全金1U"Min
5. 弹簧: SWP;
6. 拉杆: SUS304.

二、产品性能:

1. 额定值: 20V 0.5A Max
2. 接触阻抗: 100mΩ MAX;
3. 耐电压: AC 500V 1min 无击穿, 漏电流;
4. 绝缘阻抗: 1000MΩ MIN. 500V DC 测试时长1分钟;
5. 插卡力: 40N Max;  
拔卡力: 1 N Min.
6. 耐久测试: 3000次;
7. 工作温度: -25 °C to +85 °C

Unless otherwise specified tolerances are

X.X	±0.30
X.XX	±0.20
X.XXX	±0.10
X°	±3.0°
X.X°	±2.0°

**WFDconn** 深圳市旺富达电子有限公司  
SHEN ZHEN WFD ELECTRONICS CO., LTD

DRAW NO.	DATE	DRAW NAME:
DWN	LIU MIAO 19-10-21	TF 卡座 内焊 8Pin 贴片式 外壳带“T”字 黑色载带自粘
CHK	SIMON	P/N : MPT-0801-0185004
APVD	DAVID	

FINISH	UNIT	SCALE	WEIGHT	REV	SHEET
DWG NO. C-1100010110-00	mm	1:1		A0	1 OF 2



← 包装方向      客户使用方向 →

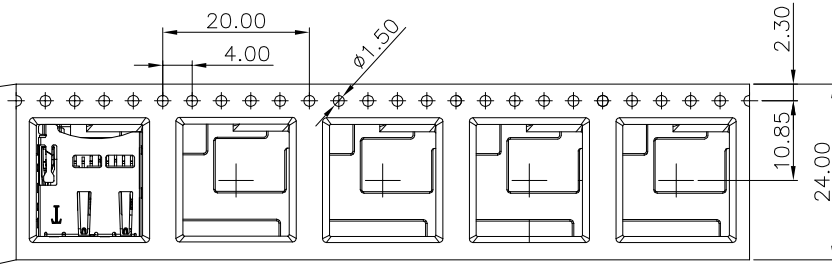

NOTES

1. 每卷包装数量: 1000PCS/每卷
  2. 卷带包装方式:  
空 15PCS      产品 1000PCS 空 5PCS
- 
- 轴心段空300mm 产品放置区 尾部 100mm

3. 每箱包装数量: 10000PCS/箱

4. 重量:

4.1 净重:            Kg

4.2 毛重:            Kg

盖带剥离角度: 165° ~ 180°  
剥离力: 20 ~ 130g

载带

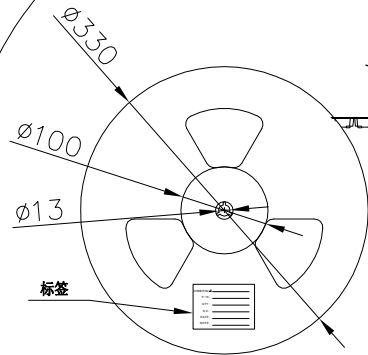

→

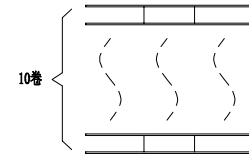

→

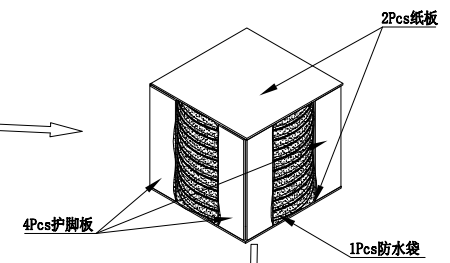

胶带封装

标签

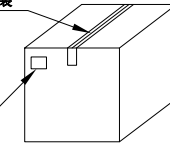

←

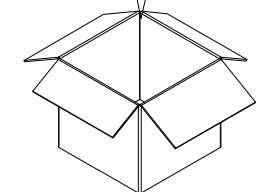

Unless otherwise specified tolerances are

X.X	±0.30
X.XX	±0.20
X.XXX	±0.10
X°	±3.0°
X.X°	±2.0°

**WFDconn** 深圳市旺富达电子有限公司  
SHEN ZHEN WFD ELECTRONICS CO., LTD

DRAW NO.	DATE	DRAW NAME:
DWN	LIU MIAO 19-10-21	TF 卡座 内焊 8Pin 贴片式 外壳带“T”字 黑色载带自粘
CHK	SIMON	P/N : MPT-0801-0185004
APVD	DAVID	

Third Angle Project	FINISH	UNIT	SCALE	WEIGHT	REV	SHEET
	DWG NO.	C-1100010110-00	mm	1:1	A0	2 OF 2