

版次(Ed')	变更摘要(Change The Content)	日期(Date)	序号	品名	材质
1	增加料号说明(Add Material Number Description)	2020/11/23	①	0.5拉拔3代股芯(H2.0) 0.5 Pitch ZIF Type 3 Housing (H=2.0)	LCP UL94V-0 本色 <b>Natural</b>
			②	0.5拉拔立式3代端子 0.5 Pitch ZIF S/T Type 3 terminal	磷青铜/表面镀锡 Phosphor Bronze/ Tin Plating
			③	0.5拉拔3代后盖(H2.0) 0.5 Pitch ZIF Type 3 Actuator (H=2.0)	LCP UL94V-0 黑色 <b>Black</b>
			④	0.5拉拔3代焊片(H2.0) 0.5 Pitch ZIF Type 3 Fitting Nail (H=2.0)	黄铜/表面镀锡 Brass/Tin Plating

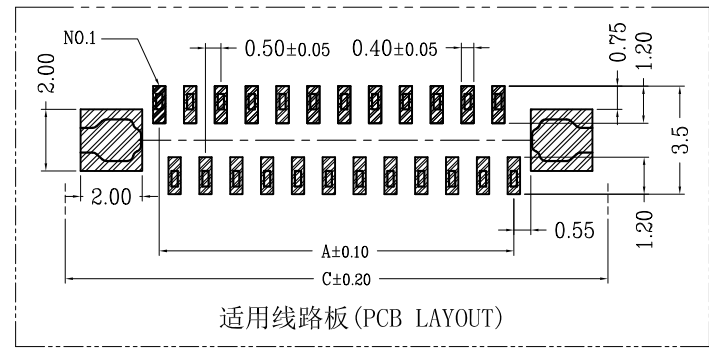
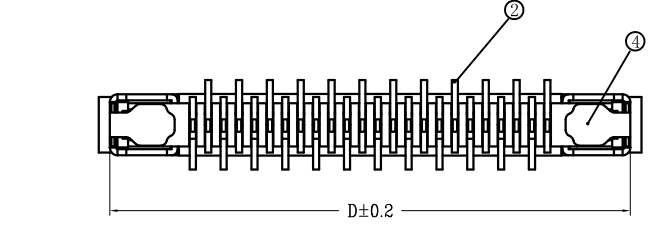
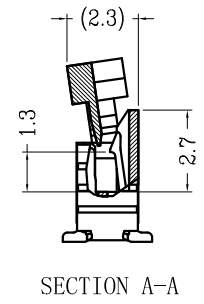
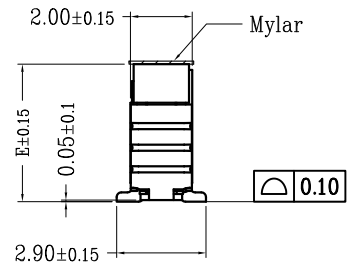
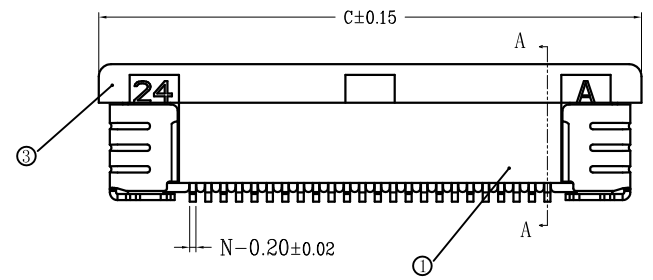
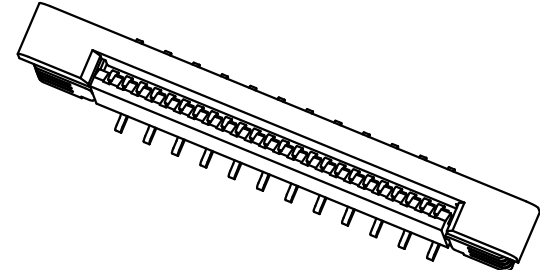

CKT	A	B	C	D	E	CKT	A	B	C	D	E
4	1.5	2.56	7.6	6.9		33	16.0	17.06	22.1	21.4	4.45
5	2.0	3.06	8.1	7.4		34	16.5	17.56	22.6	21.9	
6	2.5	3.56	8.6	7.9		35	17.0	18.06	23.1	22.4	
7	3.0	4.06	9.1	8.4		36	17.5	18.56	23.6	22.9	
8	3.5	4.56	9.6	8.9		37	18.0	19.06	24.1	23.4	
9	4.0	5.06	10.1	9.4		38	18.5	19.56	24.6	23.9	
10	4.5	5.56	10.6	9.9		39	19.0	20.06	25.1	24.4	
11	5.0	6.06	11.1	10.4		40	19.5	20.56	25.6	24.9	
12	5.5	6.56	11.6	10.9		41	20.0	21.06	26.1	25.4	
13	6.0	7.06	12.1	11.4		42	20.5	21.56	26.6	25.9	
14	6.5	7.56	12.6	11.9		43	21.0	22.06	27.1	26.4	
15	7.0	8.06	13.1	12.4		44	21.5	22.56	27.6	26.9	
16	7.5	8.56	13.6	12.9		45	22.0	23.06	28.1	27.4	
17	8.0	9.06	14.1	13.4		46	22.5	23.56	28.6	27.9	
18	8.5	9.56	14.6	13.9	4.45	47	23.0	24.06	29.1	28.4	5.00
19	9.0	10.06	15.1	14.4		48	23.5	24.56	29.6	28.9	
20	9.5	10.56	15.6	14.9		49	24.0	25.06	30.1	29.4	
21	10.0	11.06	16.1	15.4		50	24.5	25.56	30.6	29.9	
22	10.5	11.56	16.6	15.9		51	25.0	26.06	31.1	30.4	
23	11.0	12.06	17.1	16.4		52	25.5	26.56	31.6	30.9	
24	11.5	12.56	17.6	16.9		53	26.0	27.06	32.1	31.4	
25	12.0	13.06	18.1	17.4		54	26.5	27.56	32.6	31.9	
26	12.5	13.56	18.6	17.9		55	27.0	28.06	33.1	32.4	
27	13.0	14.06	19.1	18.4		56	27.5	28.56	33.6	32.9	
28	13.5	14.56	19.6	18.9		57	28.0	29.06	34.1	33.4	
29	14.0	15.06	20.1	19.4		58	28.5	29.56	34.6	33.9	
30	14.5	15.56	20.6	19.9		59	29.0	30.06	35.1	34.4	
31	15.0	16.06	21.1	20.4		60	29.5	30.56	35.6	34.9	
32	15.5	16.56	21.6	20.9							

技术指标 (Technical Index):

- 塑件表面应光洁、无毛边、无明显收缩、缺陷、裂纹等现象。  
(The surface of the plastic parts should be smooth, no rough edges, no obvious shrinkage, defects, cracks and other phenomena.)
- 温度范围(Temperature range): -25° C~+85° C.
- 额定电压(Rated voltage): 50V, AC/DC(=等效).
- 接触电阻(Contact resistance): ≤0.03Ω.
- 绝缘电阻(Insulation resistance): ≥500MΩ.
- 产品料号(Product material No.):

CFPCLL05454A-\*\*\* \* -\*\*\*

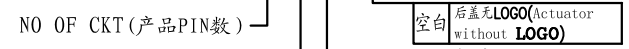

- Plating (电镀方式):  
 0: 端子全雾锡 (Terminal all mist tin)  
 1: 端子全金 (Terminal G/F OVERALL)
- Packing (包装方式):  
 R: TUBE管装  
 T: TAPE & REEL卷装  
 M: TAPE & REEL WITH MYLAR贴MYLAR卷装  
 N: TUBE & WITH MYLAR贴MYLAR管装  
 C: TAPE & REEL WITH COVER加吸盖卷装

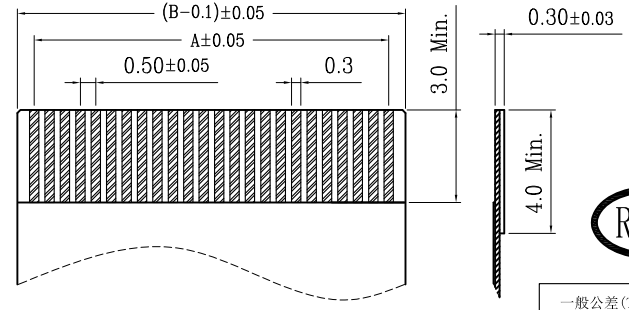

适用扁平线 (Applicable Flat Cable)



一般公差 (TOLERANCE)  
 X ±0.50 XX ±1.0  
 X ±0.20 XXX ±0.5  
 ANGLES ±1°

**WFD** CONN 深圳市旺富达电子有限公司  
 SHEN ZHEN WFD ELECTRONICS CO., LTD

品名 (TITLE): 0.5 Pitch 拉拔立式全包反脚位  
 0.5 Pitch H4.5 ZIF S/T Reversed Pointer Type CONN.

料号 (DWG.NO): CFPCLL05454A-\*\*\*\*-\*\*\*

比例 (SCALE): 1:1 单位 (UNITS): mm

制图 (DR): Liu Miao  
 校对 (CHKD): SIMON  
 审核 (APPD): DAVID

张数 (SHEET): 1 OF 1 SIZE: A4 REV: A