

REV.	ECN NO	LOCATIONS	DESCRIPTION	DATE

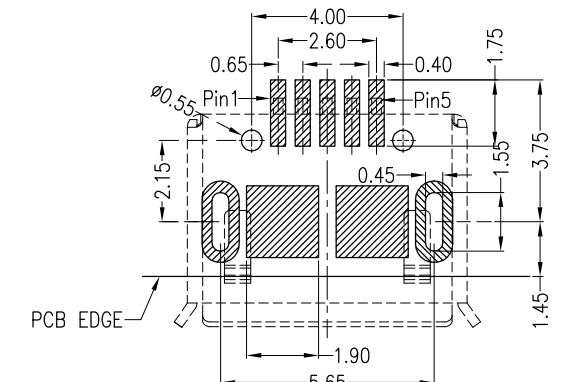
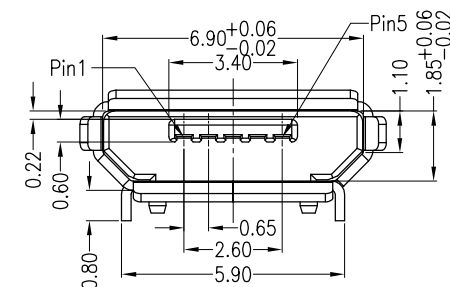
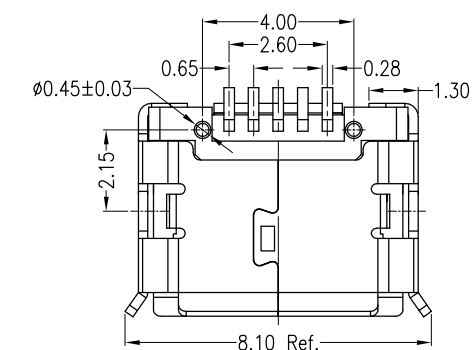
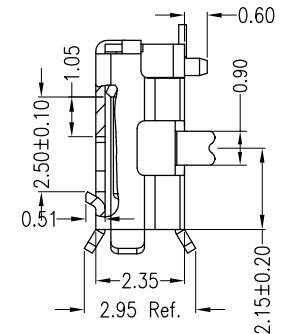
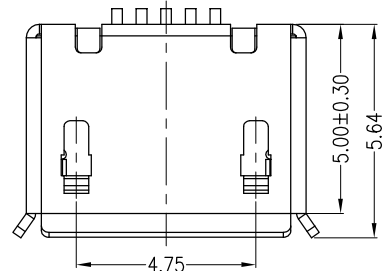
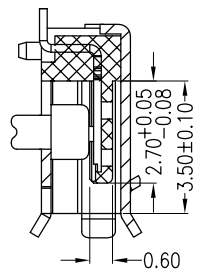
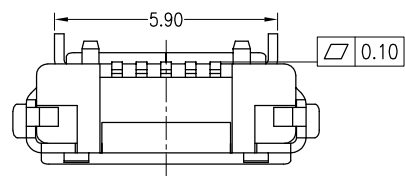

RECOMMENDED PCB LAYOUT

PCB图仅供参考

Note:

1.Material:

- 1.1 Housing: High temperature thermoplastic with g.f,UL94v-0
- 1.2 Contact: copper alloy,t=0.20mm
- 1.3 Shell: copper alloy,t=0.25mm

2.Specification:

- 2.1 Current rating:1,5PIN 1.8A Max/2,3,4PIN 1A Max.
- 2.2 Dielectric withstanding voltage: 100 V(ac) for 1 min.
- 2.3 Contact resistance: 30 mΩ Max.
- 2.4 Insulation resistance: 100 MΩ Min.
- 2.5 Total mating force: 3.57 Kgf Max.
- 2.6 Total unmating force: 1.0 Kgf Min.
- 2.7 Temperature range: -30°C~80°C

外壳材质
1:C288R-H

外壳电镀
1:NEU'
2:雾150μ'
3:N+Au1μ'
4:Au1μ'

端子电镀 01:Au1μ';02:Au1.5μ';03:Au1μ'
05:Au5μ';10:Au10μ';15:Au15μ';30:Au30μ'

主体颜色 B:黑色

主体材质 1:LOP

端子材质 4:CS191R-BH

PART NO: USB-F06505-SC082		MATERIAL: SEE NOTE		WFDconn 深圳市旺富达电子有限公司 SHEN ZHEN WFD ELECTRONICS CO., LTD	
MODEL NO: XX		FINISH: SEE NOTE			
UNIT: MM	SIZE: A4	COLOR: SEE NOTE		TITLE: Micro usb 5s B Type 有脚柱插板5.9锡脚加长0.4	
TOLERANCE UNSPECIFIED		DR: LIU MIAO		DWG NO: A035	
.x 0.15		CHK: SIMON		REV: A	
.xx 0.10		APP: DAVID		SCALE: 5:1	
.xxx 0.05				DATE: 2012.05.21	
Ang. 1°					