

REV.	ECN NO	LOCATIONS	DESCRIPTION	DATE

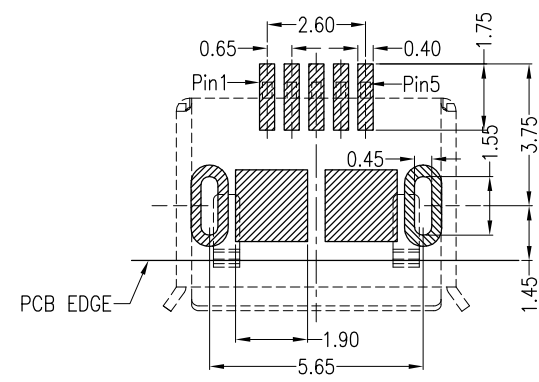
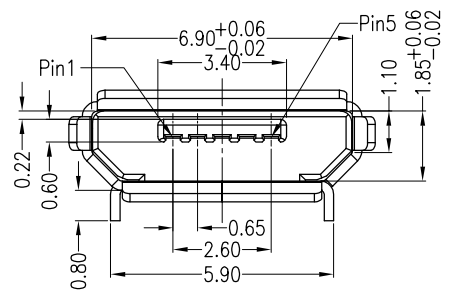
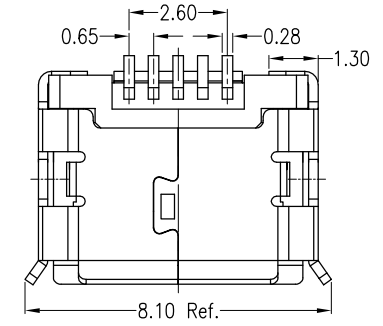
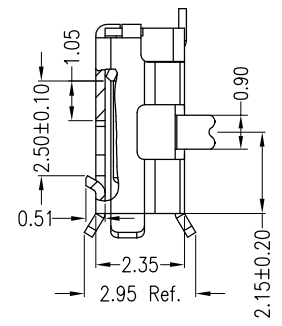
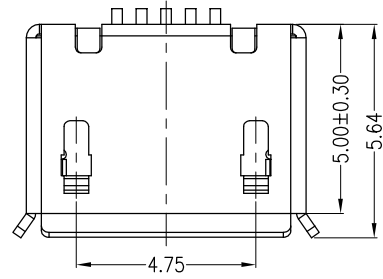
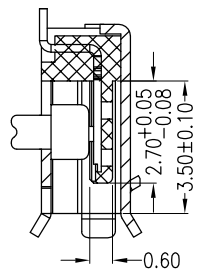
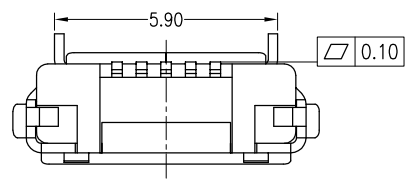

RECOMMENDED PCB LAYOUT
PCB图仅供参考

- Note:
- Material:
 - Housing: High temperature thermoplastic with g.f,UL94v-0
 - Contact: copper alloy,t=0.20mm
 - Shell: copper alloy,t=0.25mm
 - Specification:
 - Current rating:1,5PIN 1.8A Max/2,3,4PIN 1A Max.
 - Dielectric withstanding voltage: 100 V(ac) for 1 min.
 - Contact resistance: 30 mΩ Max.
 - Insulation resistance: 100 MΩ Min.
 - Total mating force: 3.57 Kgf Max.
 - Total unmating force: 1.0 Kgf Min.
 - Temperature range: -30°C~80°C

外壳材质
1:2680R-H

外壳电镀
1:NEOL'
2:雾150μ'
3:N+Au1μ'
4:Au1μ'

端子电镀 01:Au1μ';02:Au1.5μ';03:Au1μ'
05:Au5μ';10:Au10μ';15:Au15μ';30:Au30μ'

主体颜色 B:黑色

主体材质 1:LOP

端子材质 4:CS191R-BH

PART NO: USB-F06505-SC087		MATERIAL: SEE NOTE
MODEL NO: XX		FINISH: SEE NOTE
UNIT: MM	SIZE: A4	COLOR: SEE NOTE
TOLERANCE UNSPECIFIED		DR: LIU MIAO
.x	0.15	CHK: SIMON
.xx	0.10	APP: DAVID
.xxx	0.05	
Ang.	1°	

WFDconn 深圳市旺富达电子有限公司
SHEN ZHEN WFD ELECTRONICS CO., LTD

TITLE:
Micro usb 5s B Type 无柱插板5.9锡脚加长0.4

DWG NO: A198 REV: A

SCALE: 5:1 DATE: 2012.05.21